

WS9 SERIES WALL MODULE FOR USE WITH FAN COIL UNITS

PRODUCT INFORMATION



SCOPE OF APPLICATION

The WS9 Series wall module is a temperature control device with an LCD display designed on the basis of the standard 86 wall-mount installation box. The units feature Modbus communications, monitor the actual room temperature and the set temperature in real time to control the opening/closing of the valves in the fan coil units to regulate the room temperature. The WS9 Series wall modules provide anti-freeze protection, as well as manual and automatic fan speed control.

The WS9 Series wall modules work with fan coil units and regulate the room temperature by controlling the fan speed and the opening/closing of the valves. The modules usually work with the fan coil unit control valves.

PERFORMANCE HIGHLIGHTS

- Extra large LCD and operating interface
- Temperature display selection (room temperature or set temperature)
- Manual or automatic fan speed selection
- Anti-freeze protection
- Operating buttons lock/unlock
- Temperature range setting
- Standard 86 wall-mount installation box
- Modbus communication
- Timer OFF
- Energy-saving mode (activated by remote sensor/room card)

TECHNICAL PARAMETERS

COMMUNICATION PROTOCOL & BAUD RATE:	RS485 MODBUS 4800/9600 (DEFAULT)
OPERATING VOLTAGES:	100–240VAC 50/60HZ 24VAC±10% 50/60HZ
CONTROL ACCURACY:	±1°C
CONTROL SIGNAL:	ON/OFF OUTPUT
LOAD CAPACITY	
FAN:	RESISTIVE LOAD 3A INDUCTIVE LOAD 1A
VALVE:	RESISTIVE LOAD 2A INDUCTIVE LOAD 0.6A
PROTECTION RATING:	IP20
TEMPERATURE SETTING RANGE:	10–32°C
TEMPERATURE DISPLAY RANGE:	0–37°C
OPERATING TEMPERATURE:	-10 to 49°C
SHIPPING TEMPERATURE:	-30 to 60°C
RELATIVE HUMIDITY:	5–90% RH NON-CONDENSATING
REMOTE SENSOR TYPE:	NTC20K

Honeywell

ORDERING PART NUMBERS

PART NUMBER	OPERATING VOLTAGES	APPLICATIONS	BACKLIGHT	VENTILATION MODE
WS9B2WB	100-240VAC	2-pipe	White	Yes
WS9B4WB	100-240VAC	4-pipe	White	Yes
WS9E2WB	24VAC±10%	2-pipe	White	Yes
WS9E4WB	24VAC±10%	4-pipe	White	Yes

Note: The default Baud rate is 9,600 bit/s. If you require units with a Baud rate of 38,400 bit/s, please contact the marketing department.

PRODUCT DETAILS

OUTLOOK DESIGN

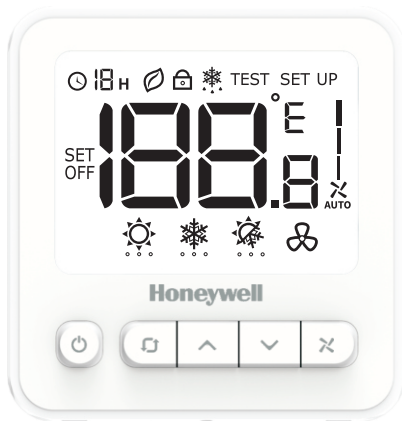

LCD

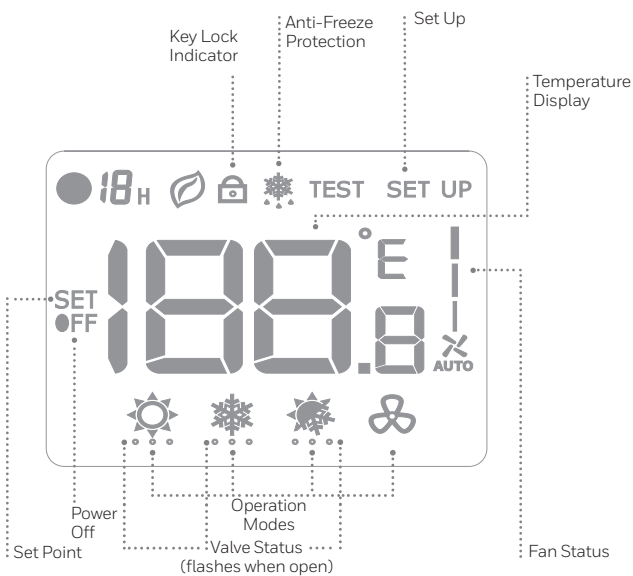

FUNCTION

VALVE AND FAN CONTROL

The wall module reads the room temperature from the built-in sensor and maintains the set temperature by sending on/off commands to the valve. There are three fan speeds which can be set manually or automatically. In manual mode, the fan speed is adjusted by FH, FM and FL outputs. In automatic mode, the fan speed will be decided by the difference between the room temperature and the set value. The fan will shut down when the valve is not operating.

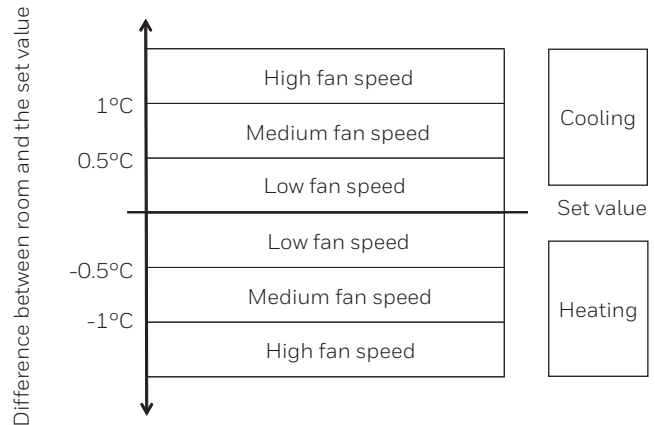

Figure 1. Automatic Fan Speed Control Algorithm

TEMPERATURE DISPLAY

Either the room temperature or the set temperature can be displayed. This can be done when installing and setting up the wall module.

BACKLIGHT

The backlight is activated when any button is pressed. It remains on for 8 seconds after the last button pressed. In setup mode, the backlight remains on for 60 seconds after the last button pressed.

KEYPAD LOCKOUT

It is possible to lock or unlock the keypad while the device is not in setting mode. When locked out, the keypad will be not respond when any of the buttons are pressed.

PRODUCT SIZE (mm)

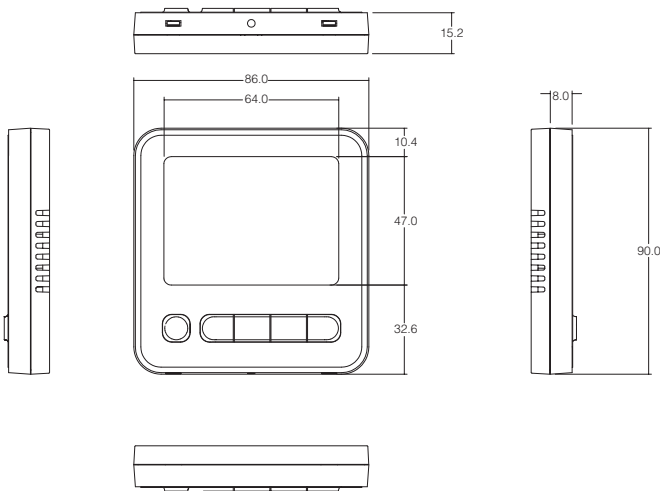

OPERATION MODES

COMFORT MODE

In Comfort Mode, press the Up or Down button to set the temperature. Comfort Mode includes cooling, heating and automatic functions.

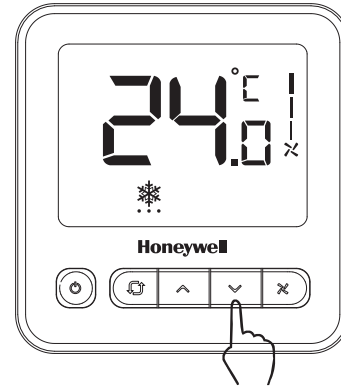

VENTILATION MODE

Press the mode key to enter Ventilation Mode. In Ventilation Mode, the fan will run at the manually set speed, with the valves shut down.

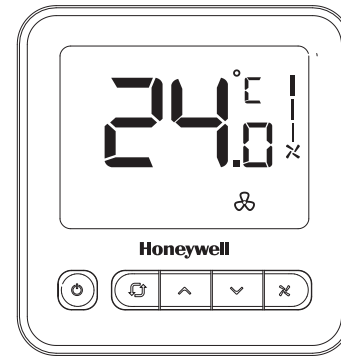

ANTI-FREEZE MODE

Anti-Freeze Mode is an option when heating. In Anti-Freeze Mode, when the room temperature falls below 6°C, the wall module (in OFF status) will begin heating automatically until the room temperature reaches 8°C.

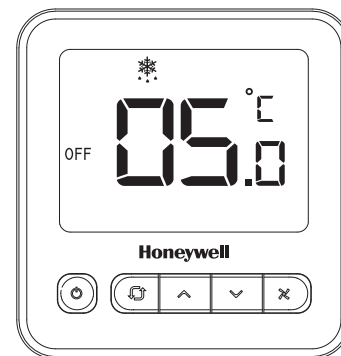

PRODUCT WIRING DIAGRAM

Part number: WS9B2WB/U Two-Pipe Application

WIRING DIAGRAM

220V 2-wired

Motorized valve wiring diagram

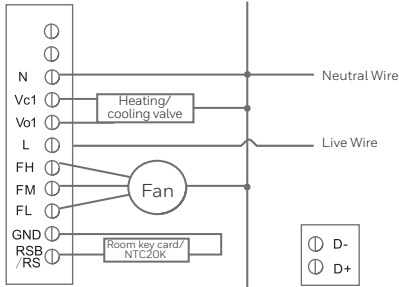

Part number: WS9B4WB/U Four-Pipe Application

WIRING DIAGRAM

220V 4-wired

Motorized valve wiring diagram

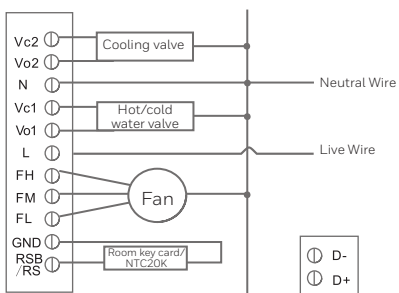

Part number: WS9E2WB/U Two-Pipe Application

WIRING DIAGRAM

24V 2-wired

Motorized valve wiring diagram

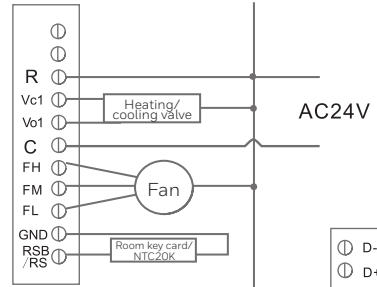

Part number: WS9E4WB/U Four-Pipe Application

WIRING DIAGRAM

24V 4-wired

Motorized valve wiring diagram

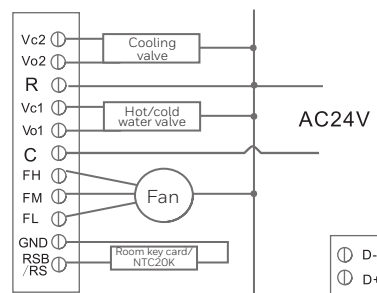

TERMINAL DEFINITION

SYMBOL	DESCRIPTION
vC2	Cooling valve is closed (four-pipe only)
vO2	Cooling valve is open (four-pipe only)
N	Power neutral wire
vC1	Heating/cooling valve is closed
vO1	Heating/cooling valve is open
L	Power live wire
FH	High fan speed
FM	Medium fan speed
FL	Low fan speed
GND	
RSB/RS	Room key card/NTC20K
D+	Modbus 485+
D-	Modbus 485-

TROUBLESHOOTING

SYMPTOM	SOLUTION
☀ FAILS TO ACTIVATE	<ul style="list-style-type: none"> Press to set the operation mode to ☀ (Heating Mode). Check whether the set temperature is higher than the room temperature. Check whether the valve status indicator is flashing. Wait for 5 minutes and check whether the heating system starts.
❄ FAILS TO ACTIVATE	<ul style="list-style-type: none"> Press to set the operation mode to ❄ (Cooling Mode). Check whether the set temperature is lower than the room temperature. Check whether the valve status indicator is flashing. Wait for 5 minutes and check whether the cooling system starts.
🔒 DOES NOT WORK	<ul style="list-style-type: none"> Check whether the buttons are locked. Check whether the unit is OFF.
⚡ DOES NOT WORK	<ul style="list-style-type: none"> Check whether the buttons are locked. Check whether it is in mode. Check whether the unit is OFF.